

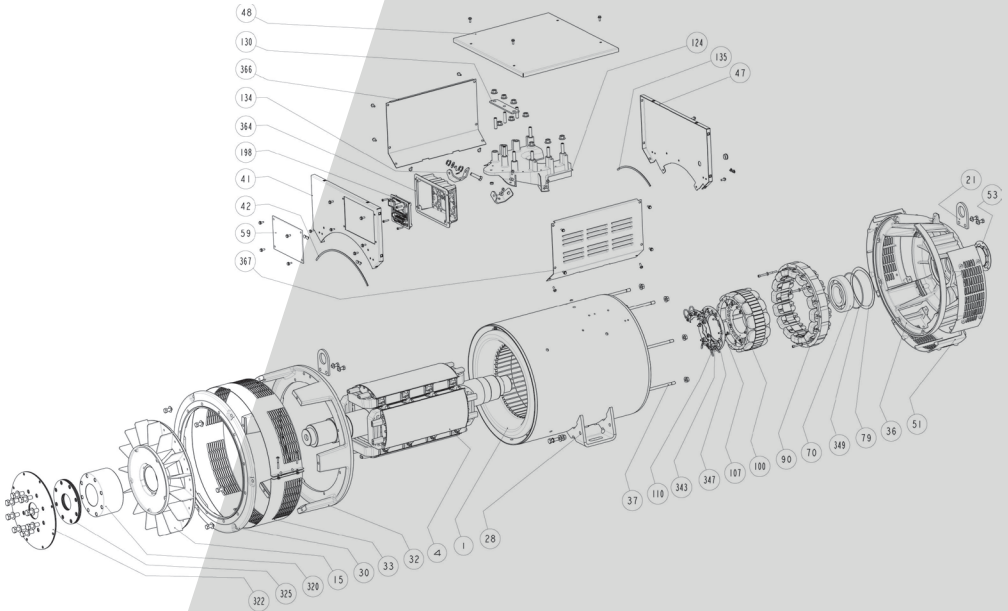

Power



LSA 46.3

Low Voltage Alternator - 4 poles

Installation and maintenance

LSA 46.3

Low Voltage Alternator - 4 poles

**This manual concerns the alternator which you have just purchased.
We wish to draw your attention to the contents of this maintenance manual.**

SAFETY MEASURES

Before using your machine for the first time, it is important to read the whole of this installation and maintenance manual.

All necessary operations and interventions on this machine must be performed by a qualified technician.

Our technical support service will be pleased to provide any additional information you may require.

The various operations described in this manual are accompanied by recommendations or symbols to alert the user to potential risks of accidents. It is vital that you understand and take notice of the following warning symbols.

WARNING

Warning symbol for an operation capable of damaging or destroying the machine or surrounding equipment.



Warning symbol for general danger to personnel.



Warning symbol for electrical danger to personnel.

SAFETY INSTRUCTIONS

We wish to draw your attention to the following 2 safety measures which must be complied with:

a) During operation, do not allow anyone to stand in front of the air outlet guards, in case anything is ejected from them.

b) Do not allow children younger than 14 to go near the air outlet guards.

A set of self-adhesive stickers depicting the various warning symbols is included with this maintenance manual. They should be positioned as shown in the drawing below once the machine has been fully installed.

WARNING

The alternators must not be put into service until the machines in which they are to be incorporated have been declared compliant with EC Directives plus any other directives that may be applicable.

This manual is to be given to the end user.

The range of electric alternators and their derivatives, manufactured by us or on our behalf, comply with the technical requirements of the customs Union directives.

The alternator is a sub-assembly delivered without a system of protection against short-circuits. The protection must be provided by the circuit-breaker of the generator, sized to interrupt the fault current.

© 2026 Moteurs Leroy-Somer SAS
Share Capital: 32,239,235 €, RCS Angoulême
338 567 258.

We reserve the right to modify the characteristics of this product at any time in order to incorporate the latest technological developments. The information contained in this document may therefore be changed without notice.

This document may not be reproduced in any form without prior authorization.

All brands and models have been registered and patents applied for.

LSA 46.3

Low Voltage Alternator - 4 poles

CONTENTS

1 - RECEIPT	4
1.1 - Standards and safety measures	4
1.2 - Inspection	4
1.3 - Identification	4
1.4 - Storage	4
1.5 - Applications	4
1.6 - Usage restrictions	4
 2 - TECHNICAL CHARACTERISTICS	 5
2.1 - Electrical characteristics	5
2.2 - Mechanical characteristics	5
 3 - INSTALLATION	 6
3.1 - Assembly	6
3.2 - Checks prior to first use	6
3.3 - Terminal connection diagrams	7
3.4 - Commissioning	11
3.5 - Setting up	11
 4 - SERVICING - MAINTENANCE	 12
4.1 - Safety measures	12
4.2 - Routine maintenance	12
4.3 - Bearings	13
4.4 - Mechanical defects	13
4.5 - Electrical faults	14
4.6 - Dismantling, reassembly	16
4.7 - Installation & maintenance of the PMG	18
4.8 - Table of characteristics	18
 5 - SPARE PARTS	 20
5.1 - First maintenance parts	20
5.2 - Technical support service	20
5.3 - Accessories	20
5.4 - Exploded views, parts list and tightening torque	21

Disposal and recycling instructions

EC Declaration

LSA 46.3

Low Voltage Alternator - 4 poles

1 - RECEIPT

1.1 - Standards and safety measures

Our alternators comply with most international standards.

See the EC Declaration of Incorporation on the last page.

1.2 - Inspection

On receipt of your alternator, check that it has not suffered any damage in transit. If there are obvious signs of knocks, contact the transporter (you may be able to claim on their insurance).

1.3 - Identification

The alternator is identified by means of a nameplate fixed on the machine (see drawing).

Make sure that the nameplate on the machine conforms to your order.

So that you can identify your alternator quickly and accurately, we suggest you fill in its specifications on the nameplate below.

1.4 - Storage

Prior to commissioning, machines should be stored away from humidity (< 90%). After a long period of storage, check the machine insulation (see sections 3.2 and 4.5).

To prevent the bearings from becoming marked, do not store in an environment with significant vibration.

For prolonged storage, please follow the recommendations in the transport and storage manual ref. 4954 available on our website:

www.nidecpower.com/downloads

1.5 - Applications

This alternator is mainly designed to produce electricity in the context of applications involving the use of generators.

1.6 - Usage restrictions

Use of the machine is restricted to operating conditions (environment, speed, voltage, power, etc) compatible with the characteristics indicated on the nameplate.

Nidec LEROY-SOMER™

Model	LSA		
S/N		Date	
Enclosure		Protection	
Th. Class		Altitude	
Weight		PF	
AVR		Excitation	
Excitation values	No Load	Full Load	
DE bearing			
NDE bearing			

Frequency	Hz								
Speed	min ⁻¹								
Voltage	V								
Phase									
Connection									
Cont. BR 40°C	kVA								
	kW								
	A								
Stand by PR 27°C	kVA								
	kW								
	A								



38537800001

MOTEURS LEROY-SOMER
2 BD MARCELLIN LEROY
16000 ANGOULÊME - FRANCE

www.leroy-somer.com

Made in Europe
by Leroy-Somer



Scan the code or go to
GEN.LS1.DO
to check product data

LSA 000-1-148 a



IEC 60034 - 1 & 5
ISO 8528 - 3
NEMA MG 1 32 & 33

LSA 46.3

Low Voltage Alternator - 4 poles

2 - TECHNICAL CHARACTERISTICS

2.1 - Electrical characteristics

This alternator is a machine without sliprings or revolving armature brushes, wound as "2/3 pitch", 12-wire, with class H insulation and a field excitation system available in either SHUNT, AREP or PMG version (see diagrams and AVR manuals).

• Electrical options

- Stator temperature detection sensors
- Bearing sensors and stators (PTC, PT100, etc)
- Space heaters
- R791 interference suppression

• SHUNT three-phase 12-wire

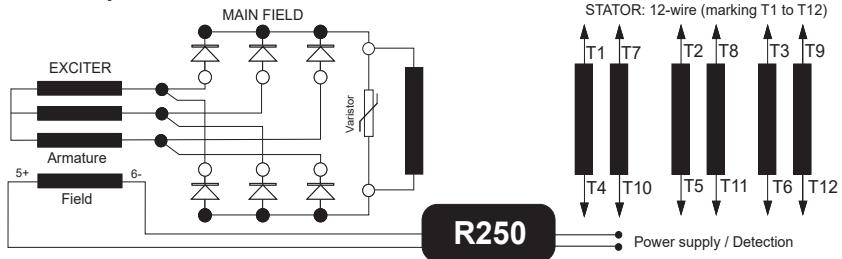

• AREP three-phase 12-wire

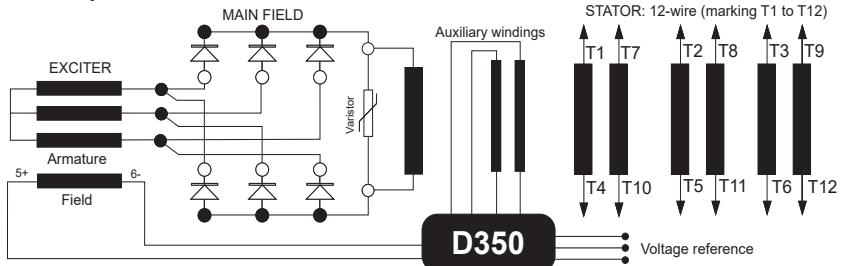

• PMG three-phase 12-wire

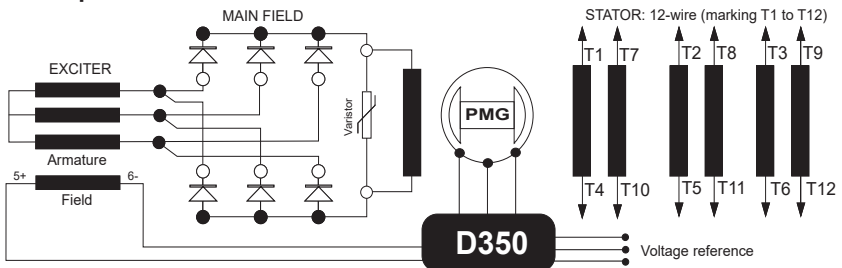

2.2 - Mechanical characteristics

- Steel frame
- Cast iron end shields
- Protected ball bearings, greased for life
- Mounting arrangement: single bearing with standard feet and SAE flanges/ coupling discs, two-bearing with SAE flange and standard cylindrical shaft extension
- Drip-proof machine, self-cooled
- Degree of protection: IP 23

• Mechanical options

- Air inlet filter
- Regreasable ball bearings
- IP 44 protection

LSA 46.3

Low Voltage Alternator - 4 poles

3 - INSTALLATION

Personnel undertaking the various operations indicated in this section must wear personal protective equipment appropriate for mechanical and electrical hazards.

3.1 - Assembly



All mechanical handling operations must be undertaken using suitable equipment and the machine must be horizontal. Check how much the machine weighs before choosing the lifting tool. During this operation, do not allow anyone to stand under the load.

• Handling

The generously-sized lifting eyes are for handling the alternator only. They must not be used to lift the genset. The choice of lifting hooks or handles should be determined by the shape of the lifting eyes. Choose a lifting system which respects the integrity and the environment of the machine.

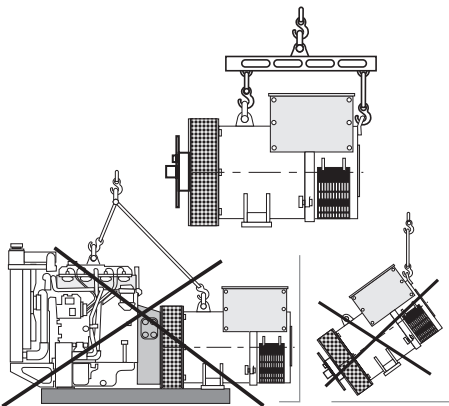

• Single-bearing coupling

Before coupling, check the compatibility between the alternator and the engine by performing:

- undertaking a torsional analysis of the transmission (alternators data are available on request),
- checking the dimensions of the flywheel and its housing, the flange, coupling discs and offset.

WARNING

When coupling the alternator to the prime mover, do not use the fan to turn the alternator or rotor.

The holes of the coupling discs should be aligned with the flywheel holes by cranking the engine.

Make sure the machine is securely bedded in position during coupling.

Check that there is lateral play on the crankshaft.

• Double-bearing coupling

- Semi-flexible coupling

Careful alignment of the machines is recommended, checking that the lack of concentricity and parallelism of both parts of the coupling do not exceed 0.1 mm.

This alternator has been balanced with a 1/2 key.

• Location

The location where the alternator is placed must be ventilated to ensure that the ambient temperature cannot exceed the data on the nameplate.

3.2 - Checks prior to first use

• Electrical checks

Disconnect the three phases at the generator terminals.

WARNING

All accessories must be disconnected (AVR, EMC filter, etc.). Refer to the electrical schematics to identify the accessories to disconnect.

LSA 46.3

Low Voltage Alternator - 4 poles

The measurement has to be taken between one phase and the earth. The reading is taken after 1 minute of test.

	Test voltage (VDC)	Criteria (MΩ ; 40°C)
Stator: U ≤ 1 kV	500	5
Rotor	500	5
Exciter (stator and rotor)	500	5
Excitation auxiliary windings (AREP)	250	5
PMG (stator)	100	5
Heating element	500	5
Temperature sensors	500	5

IEEE 43 recommendations

If the insulation resistance is not measured with a tested element à 40°C, a corrective factor has to be used.

$$R_{m\ 40^{\circ}\text{C}} = R_t \times K_{t40}$$

R_t Measured insulation resistance

K_{t40} Corrective factor

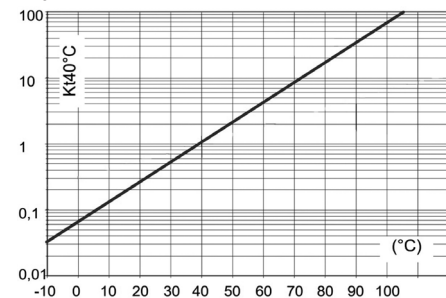

There are several possible methods for restoring the above minimum values.

a) Dry out the machine for 24 hours in a drying oven at a temperature of 110 °C (without the regulator).

b) Blow hot air into the air intake, having made sure that the machine is rotating with the exciter field disconnected.

Note: Prolonged standstill

In order to avoid these problems, we recommend the use of space heaters, as well as turning over the machine from time to time. Space heaters are only really effective if they are working continuously while the machine is stopped.

WARNING

Ensure that the alternator has the degree of protection matching the defined environmental conditions.

• Mechanical checks

Before starting the machine for the first time, check that:

- all fixing dismantled bolts are tight,
- the length and tightening torque of the added bolts are correct,
- the cooling air is drawn in freely,
- the protective grille and housing are correctly in place,
- the standard direction of rotation is clockwise as seen from the drive end (phase rotation in order 1 - 2 - 3).

For anti-clockwise rotation, swap 2 and 3.

- the winding connection corresponds to the site operating voltage (see section 3.3).

3.3 - Terminal connection diagrams

To modify the connection, change the position of the stator cables on the terminals. The winding code is specified on the nameplate.









Any intervention on the alternator terminals during reconnection or checks should be performed with the machine stopped. In no case should the internal connections in the terminal box be subjected to stresses due to cables connected by the user.

LSA 46.3

Low Voltage Alternator - 4 poles

• Voltage reconnections

Phase - Code	3-ph - D	3-ph - F	3-ph - D	3-ph - F	3-ph - A	1-ph - FF	1-ph - G
Connections							
	Star	Delta	Series Star	Delta	Parallel Star	Double Delta	Open Delta
Number of wires	6	6	12	12	12	12	12

50 Hz - 1500 rpm

	380-415V	220-240V	380-415V	220-240V	190-208V	220-240V	220-240V
Standard 6 winding	380-415V	220-240V	380-415V	220-240V	190-208V	220-240V	220-240V
Standard 6 winding	440V	-	440V	-	220V	-	-
Specific 7 winding	415-440V	240-254V	415-440V	240-254V	208-220V	240-254V	240-254V
Specific 9 winding	500-525V	-	500-525V	-	-	-	-
Specific 22 or 23 winding	550-600V	-	550-600V	-	-	-	-
Specific 10 or 52 winding	660-690V	-	660-690V	-	-	-	-

60 Hz - 1800 rpm

	380-480V	220-277V	380-480V	220-277V	190-240V	220-240V	220-240V
Standard 6 winding	380-480V	220-277V	380-480V	220-277V	190-240V	220-240V	220-240V
Specific 8 winding	380-416V	220-240V	380-416V	220-240V	190-208V	220-240V	220-240V
Specific 9 winding	600V	347V	600V	347V	-	-	-
Specific 22 or 23 winding	660-690V	-	660-690V	-	-	-	-

LSA 46.3

Low Voltage Alternator - 4 poles





• SHUNT, AREP or PMG three-phase 12-wire

Connection codes	Detection	Factory connection
<p>D 3PH Series Star</p>	<p>R250 : 0 => T8 / 110V => T11</p> <p>D350 : U => T1, V => T2, W => T3</p>	<p>DE</p> <p>NDE</p>
<p>F Delta</p> <p>1PH: consult factory for derating Voltage LM = 1/2 voltage LL</p>	<p>R250 : 0 => T8 / 110V => T11</p> <p>D350 : U => T1, V => T2, W => T3</p>	<p>DE</p> <p>NDE</p>
<p>A 3PH Parallel Star</p>	<p>R250 : 0 => T8 / 110V => T11</p> <p>D350 : U => T1, V => T2, W => T3</p>	<p>DE</p> <p>NDE</p>
<p>FF 1PH</p> <p>Voltage LM = 1/2 voltage LL</p>	<p>R250 : 0 => T4 / 110V => T1</p> <p>D350 : V => T1, W => T10</p>	<p>DE</p> <p>NDE</p>
<p>G 1PH</p> <p>Voltage LM = 1/2 voltage LL</p>	<p>R250 : 0 => T8 / 110V => T11</p> <p>D350 : V => T2, W => T3</p>	<p>DE</p> <p>NDE</p>
<p>! In case of reconnection, ensure that AVR voltage sensing is correct! The factory can supply a set of flexible shunts or special connection links as an option for making these connections.</p>		

LSA 46.3

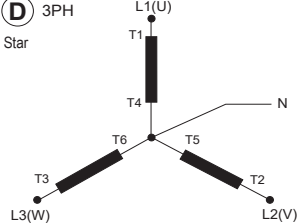
Low Voltage Alternator - 4 poles

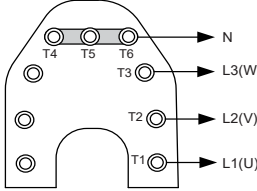
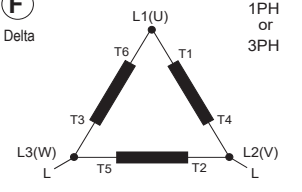
• AREP or PMG three-phase 6-wire (option)

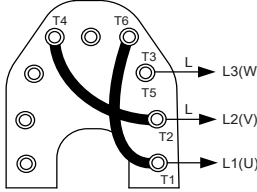
Connection codes	Detection	Factory connection
<p>(D) 3PH Star</p> 	<p>(D350) : U => T1, V => T2, W => T3</p> 	<p>DE</p>  <p>NDE</p>
<p>(F) Delta</p> <p>1PH or 3PH</p>  <p>1PH: consult factory for derating</p>	<p>(D350) : U => T1, V => T2, W => T3</p> 	<p>DE</p>  <p>NDE</p>
<p>(A) In case of reconnection, ensure that AVR voltage sensing is correct! The factory can supply a set of flexible shunts or special connection links as an option for making these connections.</p>		

LSA 46.3

Low Voltage Alternator - 4 poles

• Connection checks



Electrical installations must comply with the current legislation in force in the country of use.

Check that:

- The residual circuit-breaker conforms to legislation on protection of personnel, in force in the country of use, and has been correctly installed on the alternator power output as close as possible to the alternator. (In this case, disconnect the wire of the interference suppression module linking the neutral).
- Any protection devices in place have not been tripped.
- If there is an external AVR, the connections between the alternator and the cabinet are made in accordance with the connection diagram.
- There is no short-circuit phase-phase or phase-neutral between the alternator output terminals and the generator set control cabinet (part of the circuit not protected by circuitbreakers or relays in the cabinet).
- The machine should be connected with the busbar separating the terminals as shown in the terminal connection diagram.



- The alternator earth terminal inside the terminal box is connected to the electrical earth circuit
- The earth terminal is connected to the frame.

The connections inside the terminal box must never be subjected to stress due to cables connected by the user.



Diameter	M6	M8	M10	M12
Torque	4 Nm	10 Nm	20 Nm	35 Nm
Tolerance	± 15%			

Important points for all reconnection operations:

- Use polyamide plastic clamps 105°C minimum, 550 N minimum.

- Group the cables: three maximum.
- Do not cross cables if possible.
- Leave enough space to allow cooling.

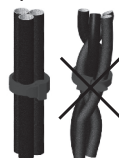

3.4 - Commissioning



The machine can only be started up and used if the installation is in accordance with the regulations and instructions defined in this manual.

The machine is tested and set up at the factory. When first used with no load, make sure that the drive speed is correct and stable (see the nameplate). With the regreasable bearing option, we recommend greasing the bearings at the time of commissioning (see section 4.3).

On application of the load, the machine should achieve its rated speed and voltage; however, in the event of abnormal operation, the machine setting can be altered (follow the adjustment procedure in section 3.5). If the machine still operates incorrectly, the cause of the malfunction must be located (see section 4.5).

3.5 - Setting up



The various adjustments during tests must be made by a qualified engineer. Ensure that the drive speed specified on the nameplate is reached before commencing adjustment.

After operational testing, replace all access panels or covers.

The AVR is used to make any adjustments to the machine.

LSA 46.3

Low Voltage Alternator - 4 poles

4 - SERVICING - MAINTENANCE

4.1 - Safety measures

Servicing or troubleshooting must be carried out strictly in accordance with instructions so as to avoid the risk of accidents and to maintain the machine in its original state.



All such operations performed on the alternator should be undertaken by personnel trained in the commissioning, servicing and maintenance of electrical and mechanical components, who must wear personal protective equipment appropriate for mechanical and electrical hazards.

Before any intervention on the machine, ensure that it cannot be started by a manual or automatic system and that you have understood the operating principles of the system.



Warning : During and after running, the alternator will reach temperatures hot enough to cause injury, such as burns.

4.2 - Routine maintenance

• Checks after start-up

After approximately 20 hours of operation, check that all fixing bolts on the machine are still tight, plus the general state of the machine and the various electrical connections in the installation.

• Electrical servicing

Commercially-available volatile degreasing agents can be used.

WARNING

Do not use: trichlorethylene, perchlorethylene, trichloroethane or any alkaline products.



These operations must be performed at a cleaning station, equipped with a vacuum system that collects and flushes out the products used.

The insulating components and the impregnation system are not at risk of damage from solvents. Avoid letting the cleaning product run into the slots.

Apply the product with a brush, sponging frequently to avoid accumulation in the housing. Dry the winding with a dry cloth. Let any traces evaporate before reassembling the machine.

• Mechanical servicing

WARNING

Cleaning the machine using water or a highpressure washer is strictly prohibited. Any problems arising from such treatment are not covered by our warranty.

Degreasing: Use a brush and detergent (suitable for paintwork).

Dusting: Use an air gun.

If the machine is fitted with air inlet and outlet filters, the maintenance personnel should clean them routinely at regular intervals. In the case of dry dust, the filter can be cleaned using compressed air and/or replaced if it is clogged.

After cleaning the alternator, it is essential to check the winding insulation (see sections 3.2 and 4.5).

LSA 46.3

Low Voltage Alternator - 4 poles

4.3 - Bearings

Standard: Permanently greased bearings	Bearings life (depending on use): 20,000 hours or 3 years (grease life)
Option: Regreased bearings	Regreasing interval: 4000 hours in operation or every 6 months Amount of grease of DE and NDE bearings: 35 gr
Replacement of regreasable bearings	Amount of grease of DE and NDE bearings: 180 gr
Standard grease	LITHIUM - standard - NLGI 3
Grease used in the factory	ESSO - Unirex N3



It is imperative to lubricate the alternator during operation and on first use. Front and rear bearing should be greased at the same time. In case of dusty environment or high ambient temperature (> 40°C), relubrication interval must be divided by two. Before using another grease, check for compatibility with the original one.

4.4 - Mechanical defects

Fault		Action/Cause
Bearing	Excessive overheating of one or both bearings (bearing temperature 80°C above the ambient temperature)	<ul style="list-style-type: none"> - If the bearing has turned blue or if the grease has turned black, change the bearing - Bearing not fully locked (abnormal play in the bearing cage) - End shields incorrectly aligned
Abnormal temperature	Excessive overheating of alternator frame (more than 40° C above the ambient temperature)	<ul style="list-style-type: none"> - Air flow (inlet-outlet) partially clogged or hot air is being recycled from the alternator or engine - Alternator operating at too high a voltage (>105% of Un on load) - Alternator overloaded
Vibrations	Too much vibration	<ul style="list-style-type: none"> - Misalignment (coupling) - Defective mounting or play in coupling - Rotor balancing fault (Engine - Alternator)
	Excessive vibration and humming noise coming from the machine	<ul style="list-style-type: none"> - Phase imbalance - Stator short-circuit
Abnormal noise	Alternator damaged by a significant impact, followed by humming and vibration	<ul style="list-style-type: none"> - System short-circuit - Misparalleling <p>Possible consequences</p> <ul style="list-style-type: none"> - Broken or damaged coupling - Broken or bent shaft end - Shifting and short-circuit of main field - Fan fractured or coming loose on shaft - Irreparable damage to rotating diodes/AVR, surge suppressor

LSA 46.3

Low Voltage Alternator - 4 poles

4.5 - Electrical faults

Fault	Action	Effect	Check/Cause
No voltage at no load on start-up	Connect a new battery of 4 to 12 volts to terminals E- and E+, respecting the polarity, for 2 to 3 seconds	The alternator builds up and its voltage is still correct when the battery is removed	- Lack of residual magnetism
		The alternator builds up but its voltage does not reach the rated value when the battery is removed	- Check the connection of the voltage reference to the AVR - Faulty diodes - Armature short-circuit
		The alternator builds up but its voltage disappears when the battery is removed	- Faulty AVR - Field windings open circuit (check winding) - Revolving field coil open circuit (check the resistance)
Voltage too low	Check the drive speed	Correct speed	Check the AVR connections (AVR may be faulty) - Field windings short-circuited - Rotating diodes burnt out - Revolving field coil short-circuited (check the resistance)
		Speed too low	Increase the drive speed (do not touch the AVR voltage setting before running at the correct speed)
Voltage too high	Adjust AVR voltage potentiometer	Adjustment ineffective	- Faulty AVR
Voltage oscillations	Adjust the AVR stability potentiometer		- Check the speed: possibility of cyclic irregularity - Loose connections - Faulty AVR - Speed too low when on load (or AVR LAM set too high)
Voltage correct at no load and too low when on load	Run at no load and check the voltage between E+ and E- on the AVR	Voltage between E+ and E- (DC) SHUNT / AREP / PMG < 10V	- Check the speed (or AVR LAM set too high)
		Voltage between E+ and E- SHUNT / AREP / PMG > 15V	- Faulty rotating diodes - Short-circuit in the revolving field coil (check the resistance) - Faulty exciter armature (check the resistance)
Voltage disappears during operation	Check the AVR, the surge suppressor, the rotating diodes, and replace any defective components	The voltage does not return to the rated value	- Exciter winding open circuit - Faulty exciter armature - Faulty AVR - Revolving field coil open circuit or short-circuited

LSA 46.3

Low Voltage Alternator - 4 poles

• Checking the winding

You can check the winding insulation by performing a high voltage test. In this case, you must disconnect all AVR wires.

WARNING

Damage caused to the AVR in such conditions is not covered by our warranty.

• Checking the diode bridge

A diode in good working order should allow the current to flow only in the anode-to-cathode direction.

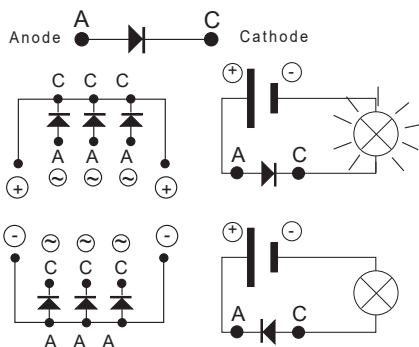

• Checking the windings and rotating diodes using separate excitation



During this procedure, make sure that the alternator is disconnected from any external load and inspect the terminal box to check that the connections are fully tightened.

- 1) Stop the unit, disconnect and isolate the AVR wires.
- 2) There are two ways of creating an assembly with separate excitation.

Assembly A: Connect a 12 V battery in series with a rheostat of approximately 50 ohms - 300 W and a diode on both exciter field wires (5+) and (6-).

ASSEMBLY A

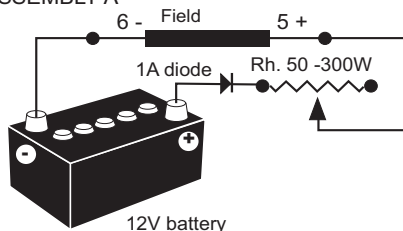

Assembly B: Connect a "Variac" variable power supply and a diode bridge on both exciter field wires (5+) and (6-).

Both these systems should have characteristics which are compatible with the field excitation power of the machine (see the nameplate).

3) Run the unit at its rated speed.

4) Gradually increase the exciter field current by adjusting the rheostat or the variac and measure the output voltages on L1 - L2 - L3, checking the excitation voltage and current at no load (see the machine nameplate or ask for the factory test report). When the output voltage is at its rated value and balanced within 1% for the rated excitation level, the machine is in good working order. The fault therefore comes from the AVR or its associated wiring (ie. sensing, auxiliary windings).

ASSEMBLY B

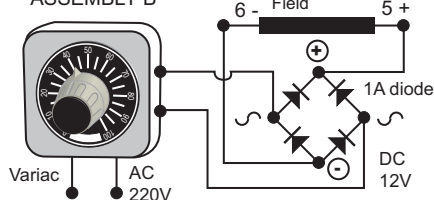

LSA 46.3

Low Voltage Alternator - 4 poles

4.6 - Dismantling, reassembly

WARNING

During the warranty period, this operation should only be carried out in an approved workshop or in our factory, otherwise the warranty may be invalidated.

Whilst being handled, the machine should remain horizontal (rotor not locked in position). Check how much the machine weighs before choosing the lifting method.

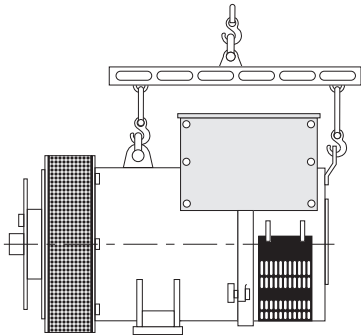

• Tools required

To fully dismantle the machine, we recommend using at least the tools listed below:

- 1 ratchet spanner + extension
- 1 torque wrench
- 1 set of flat spanners: 8 mm, 10 mm, 18 mm
- 1 socket set: 8, 10, 13, 16, 18, 21, 24, 30 mm
- 1 socket with male ferrule: 5 mm
- 1 puller

• Screw tightening torque

See section 5.4.

• Access to diodes

- Open the air intake grille (51).
- Disconnect the diodes.
- Check the diodes, change the diode bridges if necessary.

• Access to connections and the regulation system

Access is directly after removing the terminal box top panel (48) or the inspection door (59).

• Replacing the NDE bearing on single bearing machines

- Remove the air intake grille (51).
- Remove the terminal box top panel (48), the cover rear panel (47) and the side panels (366) (367).
- Disconnect the stator outputs (T1 to T12).
- Disconnect the auxiliary winding wires AREP (X1,X2,Z1,Z2).
- Disconnect the exciter wires (5+,6-).
- Remove the nuts on the tie rods (37).
- Remove the NDE bracket (36).
- Take out the antifriction bearing (70) using a puller with a central screw (see drawing below).
- Remove the bearing thrust screws (78)*.

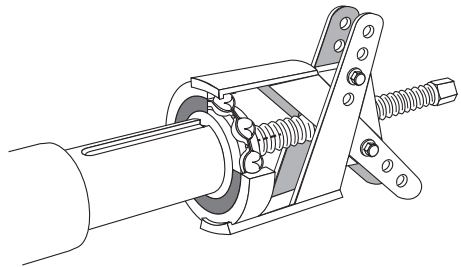

- Fit the new antifriction bearing onto the shaft after heating it by induction to approximately 80 °C.
- Mount the new preloading (wavy) washer (79) + the new "O" ring seal (349) in the bracket (36) and coat the bearing seat with adhesive paste.
- Screw a threaded rod into the thrust bearing (78)*.
- Refit the NDE bracket on the machine using a dowel and nut in the shaft extension.

* If using a regreasable machine.

LSA 46.3

Low Voltage Alternator - 4 poles

- Slide the threaded rod into the NDE bracket hole to make it easier to assemble (see basic diagram).

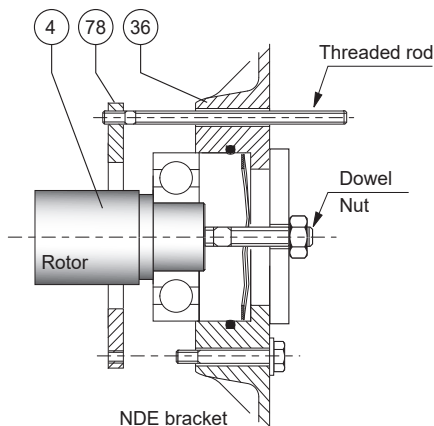

- Fit the thrust bearing screws (78)*, remove the threaded rod, fit the other screw and tighten up the assembly.
 - Tighten the NDE bracket (36) screws.
 - Reconnect wires.
 - Fit the air intake grille (51).
 - Finish reassembling the cover.

WARNING

When dismantling the brackets, you will need to change the antifriction bearings, the “O” ring seal, the preloading (wavy) washer and adhesive paste.

• Replacing the DE bearing

- Remove the air intake grille (51).
 - Untighten the NDE bracket (36) screws.
 - Remove the air outlet grille (33).
 - If using a bearing sensor option, do not forget to disconnect it.
 - Remove the DE bracket (30) screws and the inner bearing retainer (68) screws.
 - Remove the DE bracket (30).
 - Take out the antifriction bearing (60) using a puller with a central screw.

- Fit the new bearing, after heating it by induction to approximately 80 °C.
 - Screw two threaded rods into the thrust bearing*.
 - Refit the DE bracket (30) on the machine.
 - Slide the threaded rod into the bracket hole to make it easier to assemble (see basic diagram).
 - Tighten the bottom thrust bearing* screws, remove the threaded rod and fit the other screws.
 - Tighten the screws of the DE bracket (30) before tightening the NDE bracket (36) screws.
 - Refit the air grilles (33) and (51).
 - If using a bearing sensor option, do not forget to reconnect it.

• Dismantling the rotor assembly

Follow the procedure for dismantling the bearings.

If using a single bearing machine:

- Follow the procedure for dismantling the DE flange (30).
 - Remove the coupling disc (322).
 - Rest the rotor on one of its poles.
 - Support the DE rotor (4) with a strap or with a support constructed in accordance with the following drawing.
 - After extraction of the rotor, be careful not to damage the fan or dismantle it.
 - Remove the rotor on special V-shaped supports.

* If using a regreasable machine.

LSA 46.3

Low Voltage Alternator - 4 poles

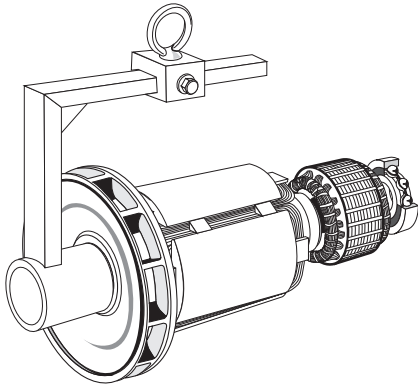

WARNING

When dismantling the rotor involves changing parts or rewinding, the rotor must be rebalanced.

• Reassembling the machine

- Follow the dismantling procedure in reverse order.

Take care not to knock the windings when refitting the rotor in the stator.

- Follow the regreasable bearing replacement procedure*.

- Tighten the screws of the DE flange or bracket (30) before tightening the NDE bracket (36) screws.

- Refit the air grilles (33) and (51).

- If using a bearing sensor option, do not forget to reconnect it.

• Dismantling and reassembly of the filters

- Remove the grille (51) then take out the filter (52). Change the filter if necessary; please refer to section 4.2 for cleaning the filter.

To replace, follow the instructions in reverse order.

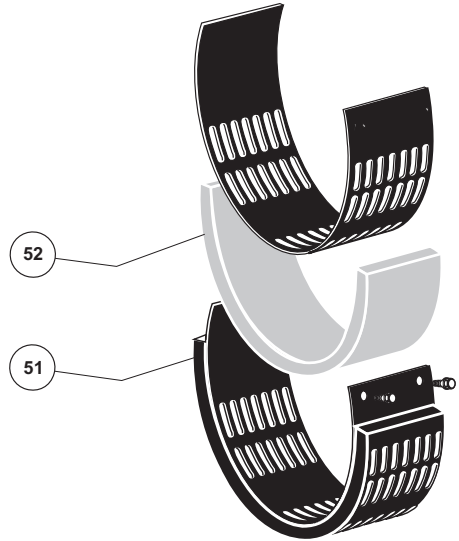

4.7 - Installation and maintenance of the PMG

The PMG reference is PMG 2.

See the PMG manual ref : 4211.

4.8 - Table of characteristics

Table of average values:

Alternator - 4 poles - 50 Hz - Standard winding No. 6 (12-wire) (400V for the excitation values).

The voltage and current values are given for no-load operation and operation at rated load with separate field excitation.

All values are given to within $\pm 10\%$ and may be changed without prior notification (for exact values, consult the test report).

* If using a regreasable machine.

LSA 46.3

Low Voltage Alternator - 4 poles

• Resistances at 20 °C (Ω)

Main armature

Type	Three-phase	
	Stator L/N	Rotor
S2	0.0258	0.254
S3	0.0201	0.270
S4/S5	0.0162	0.295
M7/M8	0.0118	0.323
L10/L11	0.0087	0.383

AREP auxiliary windings

Type	Red/black wires exciter field	
	X1, X2	Z1, Z2
S2	0.3366	0.3991
S3	0.3005	0.4611
S4/S5	0.2704	0.4396
M7/M8	0.2886	0.4802
L10/L11	0.2578	0.4042

Exciter

Type	AREP		Shunt	
	Red/black wires exciter field			
	Exciter field	Exciter armature	Exciter field	Exciter armature
S2 to S5	14.420	0.033	14.420	0.033
M7 to L11	15.539	0.035	15.539	0.035

• Field excitation currents

400V / 50 Hz (A)

Type	Three-phase	
	AREP / Shunt	
	Red/black wires exciter field	
	No load	At rated load
S2	0.70	2.92
S3	0.80	2.98
S4	0.78	3.06
S5	0.78	3.32
M7	0.94	3.14
M8	0.94	3.41
L10	0.81	2.94
L11	0.81	3.29

For 60 Hz machines, the "i exc" values are approximately 5 to 10 % lower.

• Voltages of auxiliary windings AREP (V)

Type	Red/black wires exciter field	
	X1, X2	Z1, Z2
S2 to S5	100-110	15
M7 to L11	125	15

• Table of weights (kg)

(maximum values given for information only)

Single bearing

Type	Total weight	Rotor
S2	569	245
S3	599	257
S4	674	289
S5	682	289
M7/M8	754	319
L10/L11	888	374

Two-bearing

Type	Total weight	Rotor
S2	569	218
S3	599	230
S4	674	250
S5	682	250
M7/M8	754	280
L10/L11	888	336



After operational testing, it is essential to replace all access panels or covers.

LSA 46.3

Low Voltage Alternator - 4 poles

5 - SPARE PARTS

5.1 - First maintenance parts

Here is the list of parts:

Single bearing kit	4061227
Non drive end bearing RLT075ET004	
Preloading (wavy) washer	
O ring seal	
Two-bearing kit	4061463
Drive end bearing RLT080HV001	
Non drive end bearing RLT075ET004	
Preloading (wavy) washer	
O ring seal	
Circlips	
Complete crescents equipped with diodes	4061237
Diodes: 3 direct + 3 reverse	
Surge suppressor	4691056
AVR SHUNT R250	5190337
AVR AREP D350	5124059

5.2 - Technical support service

Our technical support service will be pleased to provide any additional information you may require.

For all spare parts orders or technical support requests, send your request to service.epg@leroy-somer.com or your nearest contact, whom you will find at www.lrsom.co/support indicating the complete type of machine, its number and the information indicated on the nameplate.

Part numbers should be identified from the exploded views and their description from the parts list.

To ensure that our products operate correctly and safely, we recommend the use of original manufacturer spare parts.

In the event of failure to comply with this advice, the manufacturer cannot be held responsible for any damage.



After operational testing, it is essential to replace all access panels or covers.

5.3 - Accessories

• Space heater for use when stopped

The space heater must run as soon as the alternator stops. It is installed at the rear of the machine. Its standard power is 250W with 220V or 250W with 110V on request.



Warning: the power supply is present when the machine has stopped.

• Temperature sensors with thermistors (PTC)

These are thermistor triplets with a positive temperature coefficient installed in the stator winding (1 per phase). There can be a maximum of 2 triplets in the winding (at 2 levels: warning and trip) and 1 or 2 thermistors in the shields.

These sensors must be linked to adapted sensing relays (supplied optionally).

Cold resistance of cold thermistor sensors: 100 to 250 Ω per sensor.

• Connection accessories

- 6-wire machines : coupling (F)
- 12-wire machines : coupling (A), (F.F), (F)

LSA 46.3

Low Voltage Alternator - 4 poles

• Two-bearing

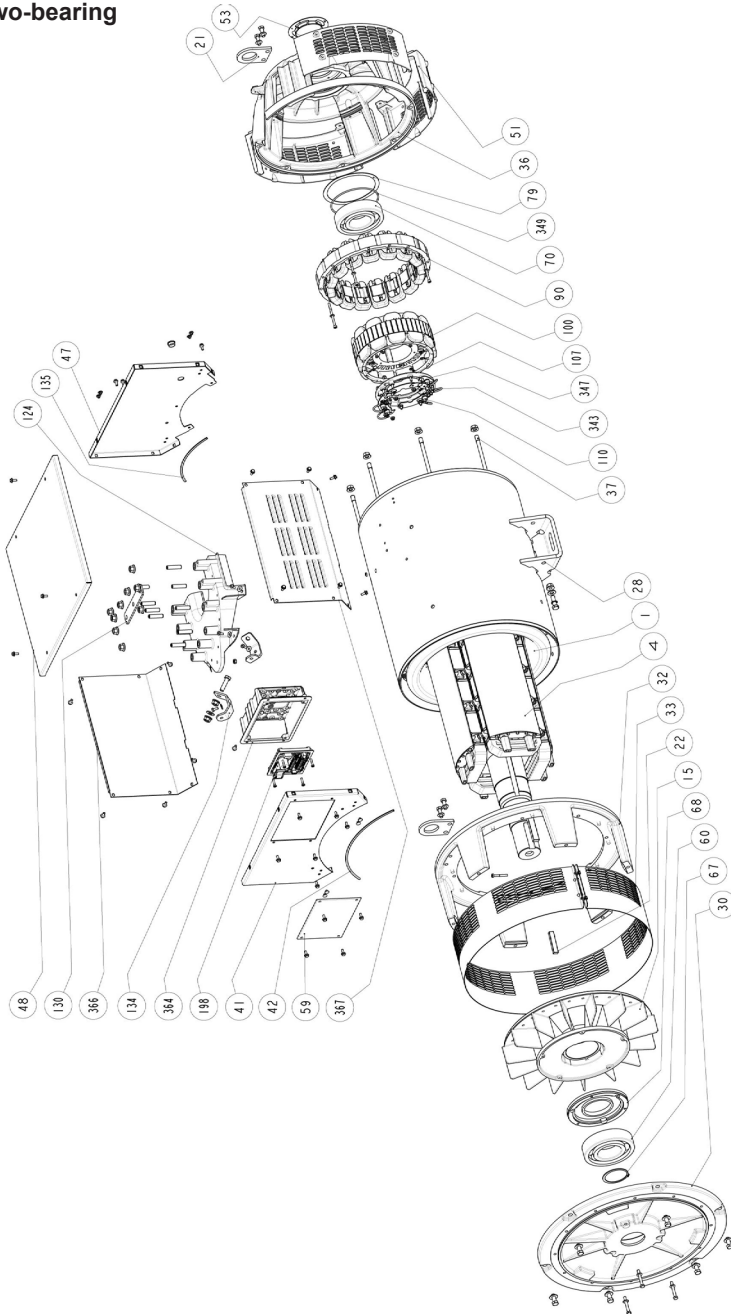

LSA 46.3

Low Voltage Alternator - 4 poles

Ref.	Qty	Description	Screw Ø	Torque N.m	Ref.	Qty	Description	Screw Ø	Torque N.m
1	1	Stator assembly	-	-	70	1	Non drive end (NDE) bearing	-	-
4	1	Rotor assembly	-	-	79	1	Preloading (wavy) washer	-	-
15	1	Fan	-	-	90	1	Exciter field (stator)	-	-
21	1	Lifting eye	M10	40	100	1	Exciter armature (rotor)	-	-
22	1	Shaft extension key	-	-	107	1	Diode bridge support	-	-
28	1	Earth terminal	M12	40	110	6	Diode	-	-
30	1	Drive end (DE) flange (single bearing) or drive end (DE) bracket (two-bearing)	M12	69	124	1	Terminal block	M6	10
32	1	Flange body	M12	69	130	1	Neutral busbar	M12	35
33	1	Air outlet grille	M6	8.3	134	2	Panel fixing	M6	10
36	1	Non drive end (NDE) bracket	M12	75	135	1	Non drive end (NDE) terminal box seal	-	-
37	8	Tie rod	-	-	198	1	Voltage regulator (AVR)	M5	6
41	1	Terminal box front panel	M6	8.3	320	1	Coupling sleeve	-	-
42	1	Drive end (DE) terminal box seal	-	-	322	3	Coupling disc	M16	170
47	1	Terminal box rear panel	M6	8.3	325	-	Spacer shim	-	-
48	1	Terminal box top panel	M6	8.3	343	1	Diode bridge assembly	M6	4
51	3	Air intake grille	M6	8.3	347	1	Surge suppressor (+ PCB)	-	-
53	1	Sealing cap	-	-	349	1	O ring seal	-	-
59	1	Inspection door	M6	4	364	1	AVR support	M6	8.3
60	1	Drive end (DE) bearing	-	-	366	1	Terminal box side panel	M6	8.3
67	1	Circlips	-	-	367	1	Terminal box side panel with air grille	M6	8.3
68	1	Inner bearing retainer	M8	20					

LSA 46.3

Low Voltage Alternator - 4 poles

Disposal and recycling instructions

We are committed to limiting the environmental impact of our activity. We continuously monitor our production processes, material sourcing and product design to improve recyclability and minimise our environmental footprint.

These instructions are for information purposes only. It is the user's responsibility to comply with local legislation regarding product disposal and recycling.

Recyclable materials

Our alternators are mainly constructed from iron, steel and copper materials, which can be reclaimed for recycling purposes.

These materials can be reclaimed through a combination of manual dismantling, mechanical separation and melting processes. Our technical support department can provide detailed directions on how to dismantle products on request.

Waste & hazardous materials

The following components and materials require special treatment and must be separated from the alternator before the recycling process:

- electronic materials found in the terminal box, including the automatic voltage regulator (198), current transformers (176), interference suppression module and other semi-conductors.
 - diode bridge (343) and surge suppressor (347), found on the alternator rotor.
 - major plastic components, such as the terminal box structure on some products.
- These components are usually marked with information concerning the type of plastic.

All materials listed above need special treatment to separate waste from reclaimable materials and should be entrusted to specialist recycling companies.

The oil and grease from the lubrication system should be treated as hazardous waste and must be treated in accordance with local legislation.

Our alternators have a specified lifetime of 20 years. After this period, the operation of the product should be stopped, regardless of its condition. Any further operation after this period will be under the sole responsibility of the user.

LSA 46.3

Low Voltage Alternator - 4 poles

Angoulême, 16th June 2024

EC Declaration

Moteurs Leroy-Somer declares hereby that the electric generators of the types:

LSA 40 – LSA 42.3 – LSA 44.3 – LSA 46.3 – LSA 47.2 – LSA 47.3 – LSA 49.1 – LSA 49.3 – LSA 50.1 – LSA 50.2 – LSA 51.2 – LSA 52.2 – LSA 52.3 – LSA 53 – LSA 53.1 – LSA 53.2 – LSA 54 – LSA 54.2 – LSA 55.3 – TAL040 – TAL 042 – TAL 044 – TAL 046 – TAL 047 – TAL 047.3 – TAL 049 – LSAH 42.3 – LSAH 44.3 as well as their derivatives, manufactured by Leroy-Somer or on Leroy-Somer's behalf:

MOTEURS LEROY-SOMER

Boulevard Marcellin Leroy
16015 Angoulême
France

LEROY-SOMER ELECTRO-TECHNIQUE Co., Ltd

No1 Almoheng Road, Galshan Town,
Cangshan District,
Fuzhou, Fujian 350026
China

MLS HOLICE STLO.SRO

Sladkovskeho 43
772 04 Olomouc
Czech Republic

NIDEC INDUSTRIAL AUTOMATION INDIA PRIVATE Ltd - BANGALORE

#45, Nagarur, Huskur Road
Off Tumkur Road,
Bengaluru-562 162
India

MOTEURS LEROY-SOMER

1, rue de la Burette
Boite Postale 1517
45800 St Jean de Braye France

NIDEC INDUSTRIAL AUTOMATION INDIA PRIVATE Ltd - HUBLI

#64/A, Main Road,
Tarihah Industrial Area,
Tarihah, Hubli-580 026
India

meet the requirements of the following standards and directives:

Declaration of compliance:

- Low Voltage Directive Nr 2014/35/EU dated 26th February 2014.
- EN and IEC 60034-1, 60034-5 and 60034-22.
- ISO 8528-3 "Reciprocating internal combustion engine driven alternating current generating sets. Part3. Alternating current generators for generating sets".

These generators also comply with the ROHS Directive Nr 2011/65/EU dated 8th June 2011 and its Annex II Nr 2015/863 dated 31st March 2015, as well as the EMC Directive Nr 2014/30/EU dated 26th February 2014.

Declaration of incorporation:

These generators are designed to meet the essential requirements Annex I, chapters 1.1.2, 1.1.3, 1.1.5, 1.3.1 to 1.3.3, 1.3.6 to 1.3.8.1, 1.4.1, 1.4.2.1, 1.5.2 to 1.5.11, 1.5.13, 1.6.1, 1.6.4, 1.7 (except 1.7.1.2) of Machinery Directive Nr 2006/42/EC, as well as Annex VII, part B of this directive and the aforementioned standards.

As a result, these "Partly completed machinery" are designed to be incorporated into Electrical Gen-Sets complying with the Machinery Directive Nr 2006/42/EC dated 17th May 2006.

WARNING:

The here mentioned generators should not be commissioned until the corresponding Gen-Sets have been declared in compliance with the Directives Nr 2006/42/EC, 2014/30/EU, 2011/65/EU and 2015/863, as well as with other relevant Directives.

Moteurs Leroy-Somer undertakes to transmit, in response to a reasoned request by the national authorities, relevant information on the generator.

Those responsible for compiling the technical files and this declaration are:

Yannick MESSIN, Technical Manager LS Orléans, 1 rue de la Burette, 45800 Saint Jean de Braye
Jean-Pierre CHARPENTIER, Technical Manager LS Sillac, Bld Marcellin Leroy, 16015 Angoulême

J.P. CHARPENTIER – Y. MESSIN

Moteurs Leroy-Somer

Headquarters: Boulevard Marcellin Leroy CS 10015 - 16915 Angoulême cedex 9 - France
T: +33 (0)5 45 64 45 64 / www.nidecpower.com

SAS with share capital of 32,239,235 € - RCS Angoulême 339 567 258.

4152 en - 2024.06 / w

The contractual EC Declaration of compliance and incorporation can be obtained from your contact on request.

LSA 46.3

Low Voltage Alternator - 4 poles

Service & Support

Our worldwide service network of over 80 facilities is at your service. Our local presence is your guarantee for fast and efficient repair, support and maintenance services.

Trust your alternator maintenance and support to electric power generation experts. Our field personnel are 100% qualified and fully trained to operate in all environments and on all machine types.

We have a deep understanding of alternators operations, providing the best value service to optimize your cost of ownership.

How can we help:

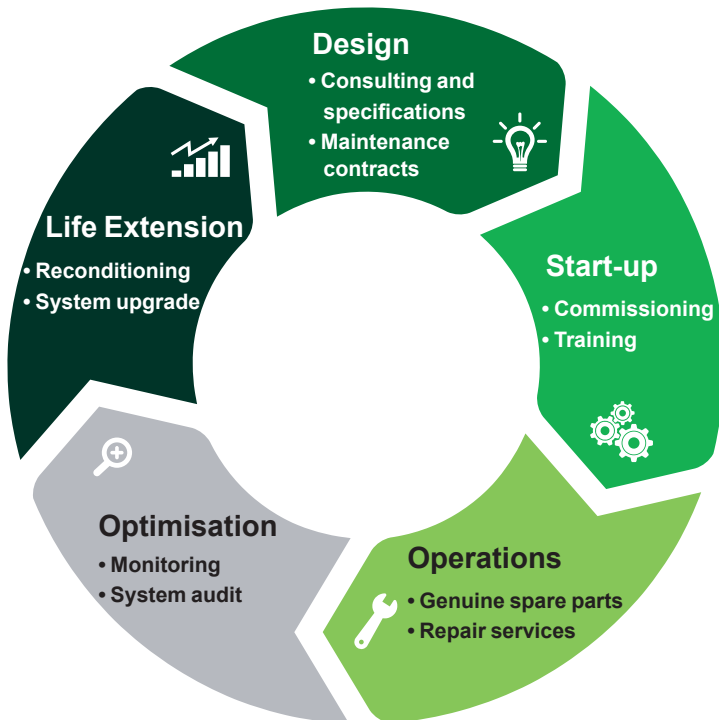

Contact us:

Americas: +1 (507) 625 4011

EMEA: +33 238 609 908

Asia Pacific: +65 6250 8488

China: +86 591 8837 3010

India: +91 806 726 4867



service.epg@leroy-somer.com



Scan the code or go to:
www.lrsom.co/support



www.nidecpower.com

Connect with us at:

